

# IEEE Milestone Recognition Honoring Innovation in Healthcare Technology

Recognizing the Historic Collaboration  
Between El Camino Health and  
Lockheed Martin



# What is IEEE?



- The Institute of Electrical and Electronics Engineers
- The world's largest technical professional organization
- Over 500,000 members in 190 countries
- Manages global industry standards such as Wi-Fi

**Core Mission:** To foster technological innovation and excellence for the benefit of humanity

# El Camino Health

El Camino Health has served the communities of Silicon Valley and the South Bay for more than 60 years, with nationally recognized physicians and nurses at two independent not-for-profit acute care hospitals in Los Gatos and Mountain View, and 28 care locations across the region, which includes primary care, multi-specialty care, and urgent care.

## **Awards & Achievements:**

- Named one of the World's Best Hospitals 2026 by Newsweek
- Best Hospitals for Maternity Care by U.S. News & World Report
- San Francisco Bay Area's first Magnet hospital for nursing excellence
- Among fewer than 2% of hospitals nationwide to receive Five Magnet Designations

# Lockheed Martin

Lockheed Martin is a global defense technology company driving innovation and advancing scientific discovery. Our all-domain mission solutions and 21st Century Security vision accelerate the delivery of transformative technologies to ensure those we serve always stay ahead of ready. The spacecraft and systems that we design, build and operate have been a part of exploring every planet in our solar system. They have landed on Mars, executed tiny orbits around asteroids, flown past Pluto and explored the Kuiper Belt. The Lockheed Martin built Orion spacecraft successfully splashed down in the Pacific Ocean on April 10, 2026, marking a major milestone in humanity's return to deep space exploration.



---

“We have never in human history  
built anything as complex as the  
modern hospital”

Peter Drucker

Widely regarded as the father of modern management

## 1956 - First Lockheed R&D Building in Palo Alto



Now site of current LM Advanced Technology Center

## 1958 - El Camino Hospital Construction begins

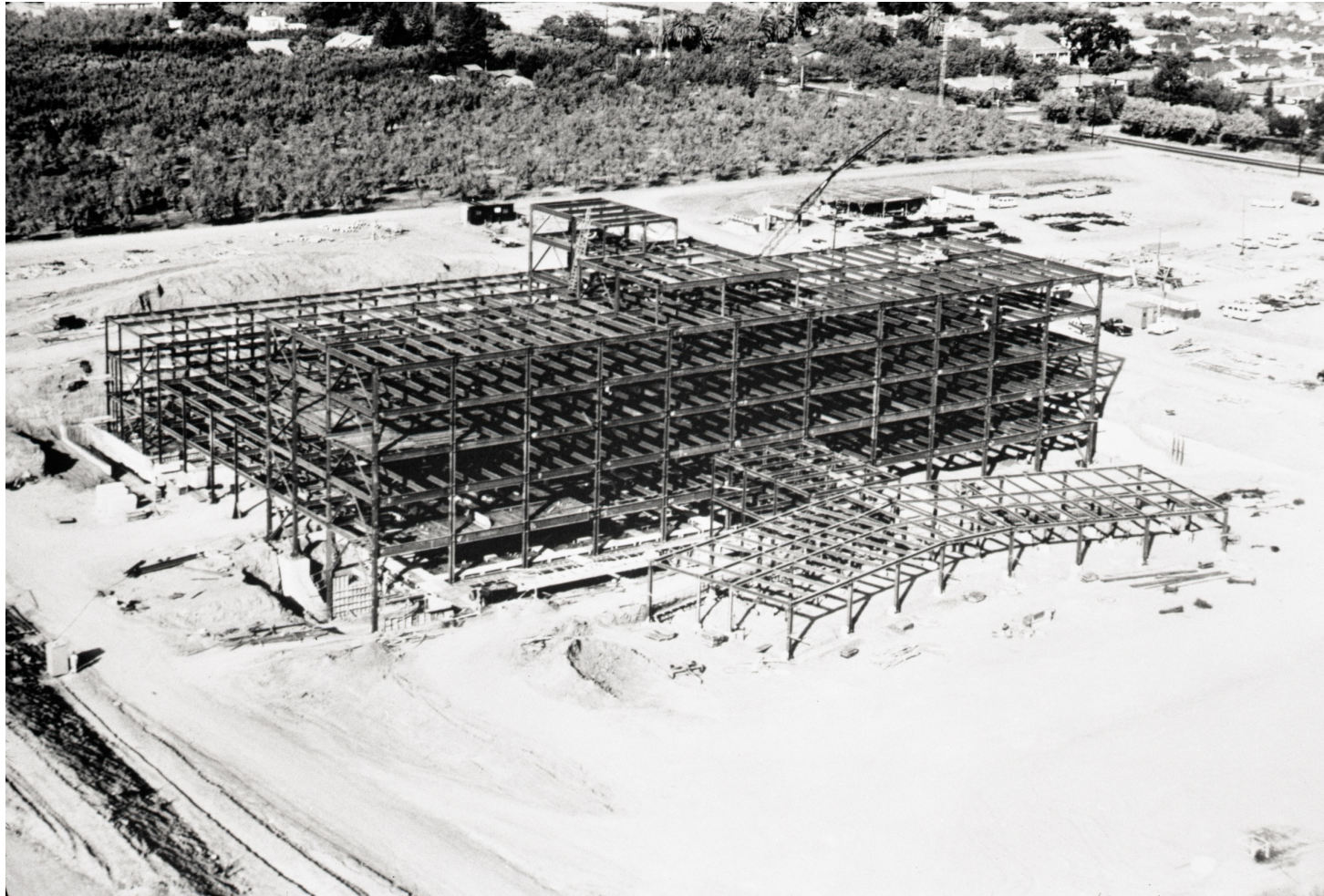

Source: El Camino Health archives

## 1961 - El Camino Hospital Opens



Source: El Camino Health archives

# Lockheed Enters Healthcare, with Government Support

1965



IEEE Milestone Recognition

## President Johnson Signs the Medicare Act - July 30, 1965



# LMSD Information Systems Vision :

## Education, Government, Medical Usage

Presented to Santa Clara County Board  
of Supervisors January 18, 1966



IEEE Milestone Recognition

# 1968 - The "Lockheed Approach" explained - SJ Mercury

## 'Lockheed Approach' Healing Hospital Communication Problems

Sam Virts, former assistant administrator of O'Connor Hospital, assured the Kiwanis luncheon audience that Lockheed Missiles & Space Co.'s systems management approach is providing a major solution to hospital communication problems.

Since he resigned his post two years ago, he has taken post-graduate work and now is Lockheed's regional representative in its hospital information system.

"Fifteen years of hospital experience had convinced me," Virts said at the club's meeting in Hotel Sante Claire, "that communication breakdown was at the root of nearly all administrative, personnel, medical staff and community relations problems in hospitals.

Few endeavors can match the communication complexity of a modern hospital which will process as many as 200,000 laboratory orders each year. Each lab order involves 10 discrete communications steps. Here alone are two million chances a year for communication breakdown.

"Add to this the equally involved communication process on medication orders, treatments, radiology, physical medicine, electroencephalography, electrocardiology and dietary orders and they all combine to produce millions of links in the medical order communication chain.

"And this is just one of the hospital communication loops.

administrative judgments."

Paper work, the Kiwanis learned from Virts, accounts for about a third of the hospital's

This systems management approach, he added, is geared to merging the special insights of social scientists with the technology of the physical scientists to achieve humanitarian goals. The result is social progress.

"There can be no doubt that our country's social, economic

and moral future rests upon man's ability to shatter the environmental chains that bind so many in a stagnating cycle of unemployment, functional illiteracy, poverty and defeat," said Virts.

"Progress is being made. The computer plays a role in all of this. . . The computer and other technology can be a tool, not a tyrant. . . Your future increasingly will be affected by

the computer, and information systems technology. "As this technology attacks problems in assessment in education, and in health progress will be made as long as there is continued meaningful communication between the worlds of social and physical science. Therein lies promise for our nation, and our civilization, that the best is yet to come."

Virts earlier described the application of the systems approach to finding solutions to a complex problem at Wilson Junior High School in San Jose, titled "Subject Readiness, Subject Relevance and Learning Reinforcement," shortened to the "R3 Program."

In essence, it shows how to excite the imagination, to ignite the drive, to stimulate the will to learn in underprivileged

youngsters who have reached the seventh grade with maximum ability in English and math.

It merges special talents from various disciplines — computer scientists, psychologists, sociologists, educator, linguists and systems design engineers.

"This project," said Virts, "is a classic example of the move toward tearing down the communication barriers be-

tween the worlds of physical and social science."

In one semester, reading levels of these pupils improved by 1.7 years; the math level by 8 years. Of greater significance was the change in attitudes. In the semester prior to the R3 program there were 55 office referrals from among the demonstration group of 34 pupils. Last semester there were only six.

**OLD COUNTRY STORE**  
**SALE!!! ... with**  
**OLD FASHIONED PRICES!**



**IT'S FUN TO BROWSE AND SHOP AT HANDY'S**

**WILLOW GLEN LUMBER CO.**  
750 WILLOW ST. — PHONE 286-4050

# HANDYMAN

**OPEN FRIDAY TILL 9 P.M.**

**BARREL O' BARGAINS!**  
SALE PRICES EFFECTIVE TODAY  
THRU TUESDAY, APRIL 2nd

OPEN 7 DAYS ★ FRIDAY 9 to 9 • SUNDAY 10 to 5 • WEEKDAYS 9 to 6

**TONIGH SCOTCH SYLVANIA LIGHT BULBS**  
60-75-100 WAT

## 8 \$1

WATCH FOR "SCOTCH DEALS" HANDY'S SERVICES FOR

**PRESTO PRESSURE COOKER PARTS OFFICIAL HEADQUARTERS**

## Critical Government Partnerships — Early Contracts

### List of Selected AHRQ-funded Contracts

<b>Contract Number</b>	<b>Contractor</b>	<b>Title</b>	<b>Year of Award</b>
110-68-0047	Lockheed Air Corporation, Sunny Vale, California	Analysis of Information Needs of Nursing Stations	1968
110-71-0128	El Camino Hospital Mountain View, California	Demonstration of Existing Hospital Information System	1971
110-73-0331	Battelle Memorial Institute Columbus, Ohio	Evaluation of the Implementation and Operation of the Technicon Medical Information System at El Camino Hospital	1973

Source: <https://pmc.ncbi.nlm.nih.gov/articles/PMC344572/>

## 1968 - Bill Childs Publishes MIS “Manifesto”

- Lockheed Software Manager
- Computers in Healthcare magazine founder 1980-95
- CHIME Foundation Industry Leader award 2010



MIS : Medical Information System Vision

## MIS Manifesto examples

Lockheed Missiles and Space Company  
Medical Information Systems Division

25 Standards for Development of MIS

4/1/68

Bill W. Childs

1. The system must respond to users at "Think Speed" to be defined as less than one second response-time from request to answer.
2. Criteria for inputting notes, orders and results will be primarily from selectable choices coded on Matrix screen. Typing will be limited to less than 5% of all input to the system.

# 1970 Lockheed Business Plans

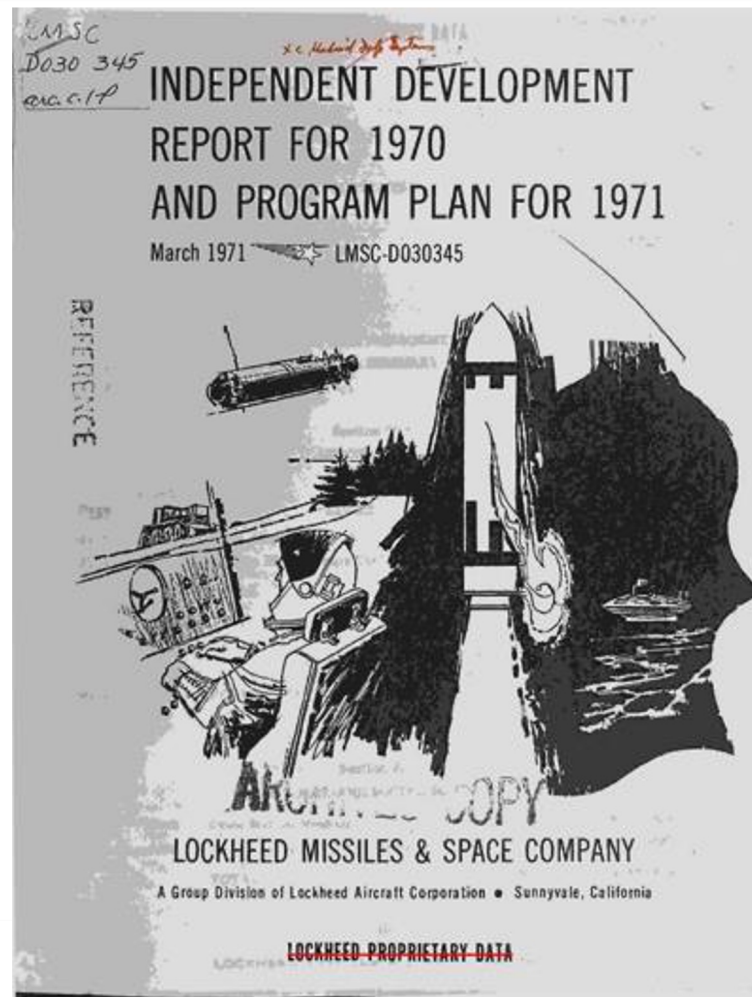

## Lockheed MIS Funding – 1970 Plan

The information contained herein is the property of Lockheed Aircraft Corporation and shall not be copied or used in any manner except as expressly authorized.

LMSC-D026020

### Medical Information Systems

FUNDING: 1969, \$1,283,000 (Professional, \$625,000, 24 man-years; Technical Support, \$40,000, 2 man-years; Material, \$11,000; Leased Equipment, \$20,000; Purchased Services, \$74,000; Computer, \$513,000)

1970, \$1,600,000 (Professional, \$917,000, 35 man-years; Technical Support, \$40,000, 2 man-years; Material, \$3,000; Leased Equipment, \$41,000; Purchased Services, \$155,000; Computer, \$444,000)

PERSONNEL: B. L. Hisey, Cognizant Manager; P. E. Williams, Project Leader; G. D. Vanlandingham, L. G. Kahn, C. A. Tapella, G. T. Uber, R. E. Boyce, S. Grams, S. D. Norman, C. Weidner; K. T. Larkin, Program Officer

# MIS-I Hospital Information Flow Diagram

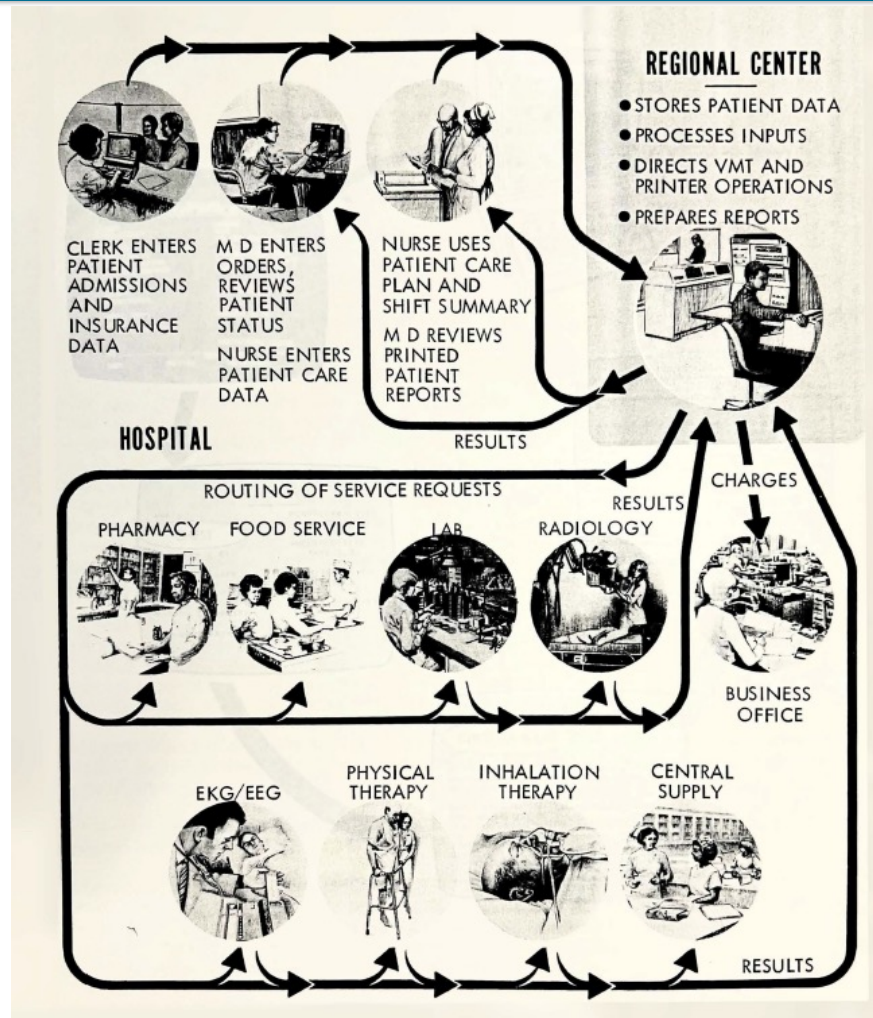



## MIS-I Block Diagram — 1960s Mainframe Architecture

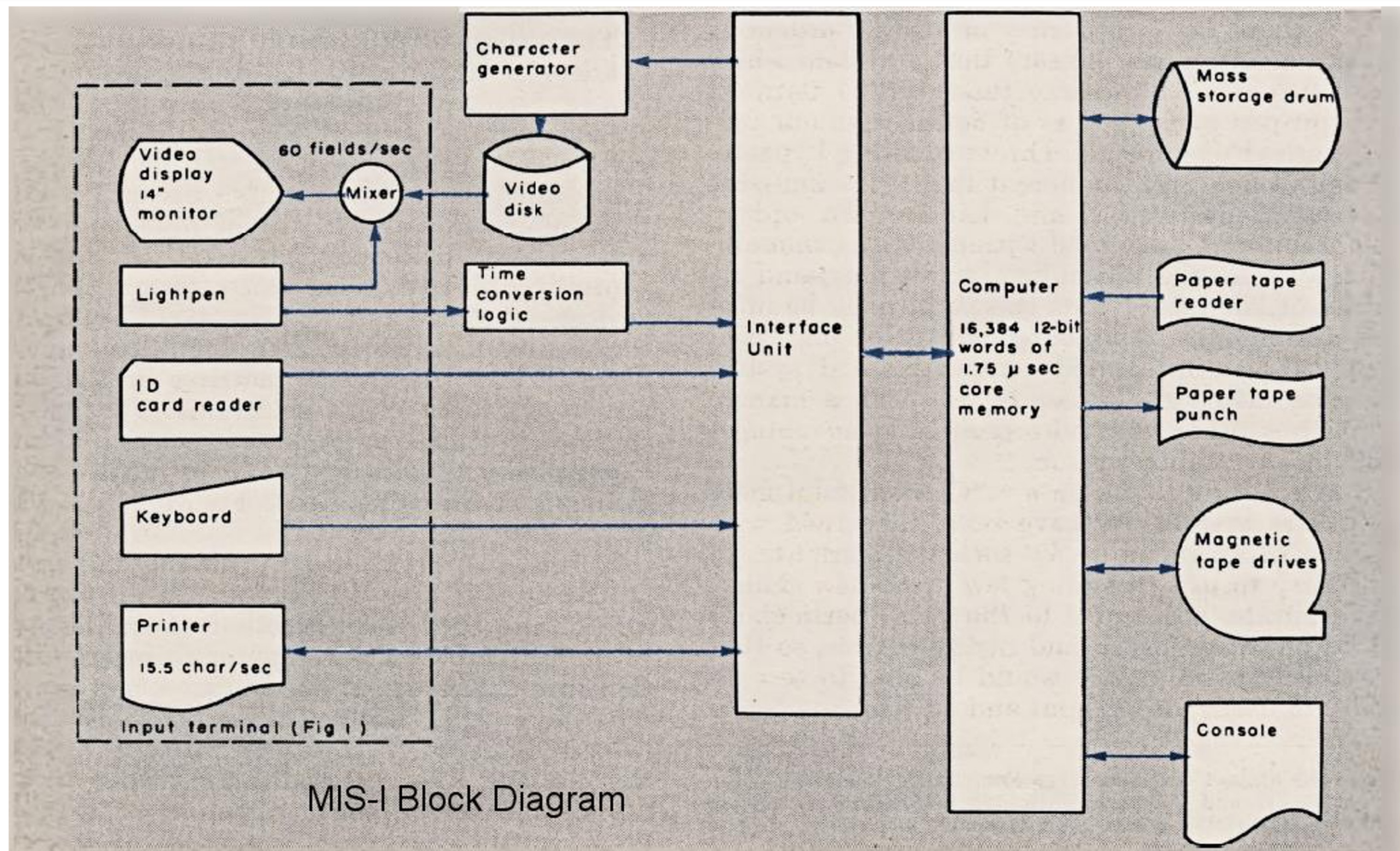

## Training Physicians to Work with Computers



*Neilson Buchanan watches as George Ting, M.D., enters orders directly into MIS for an ICU patient.*

## Light Pen – a “Pre-Cursor” to the Mouse

Early mice were being studied at SRI in Menlo Park, but they were experimental and not intuitive for doctors in 1965



Lockheed decided to “borrow” the light pen technology from their work on defense projects in the 60’s



## Physicians Generate Personalized “Order Sets”

One-click operations can be tailored to their medical practice



## Other Early Commercial Attempts Compared

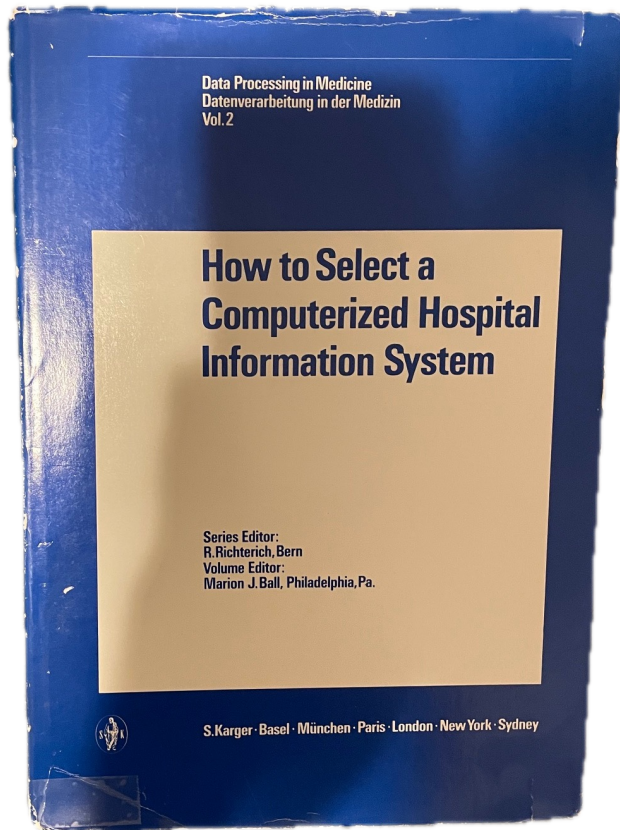

Survey of 15 early commercial hospital systems  
by Dr. Marion J. Ball, Temple University, 1973

Most other early efforts failed or fell short

**May 1971**

**Lockheed MIS Business Sold to Technicon Corp,**

**Becomes Technicon Medical Info Systems - TMIS**



**IEEE Milestone Recognition**

## Some TMIS positions for Lockheed team



Ken Larkin - President



Melville Hodge - EVP



Ralph Boyce  
On-site ECH Tech Supervisor



Charles Tapella – Chief  
System Engineer



William Helvey, M.D.  
Medical Director



Carole Weidner, R.N.  
Nursing Director

## El Camino Hospital Signs Deployment Contract– May 21, 1971

Pictured (from left) :

Edwin Hawkins –  
ECH Hospital Administrator

Ken Larkin –  
TMIS CEO

James Evans –  
Technicon Corp SVP



# Public Controversy as Early Issues are Addressed before Final Acceptance

1971–1974

Nurses and surgeons support; internists resist

# Physicians Deeply Split – July 1972

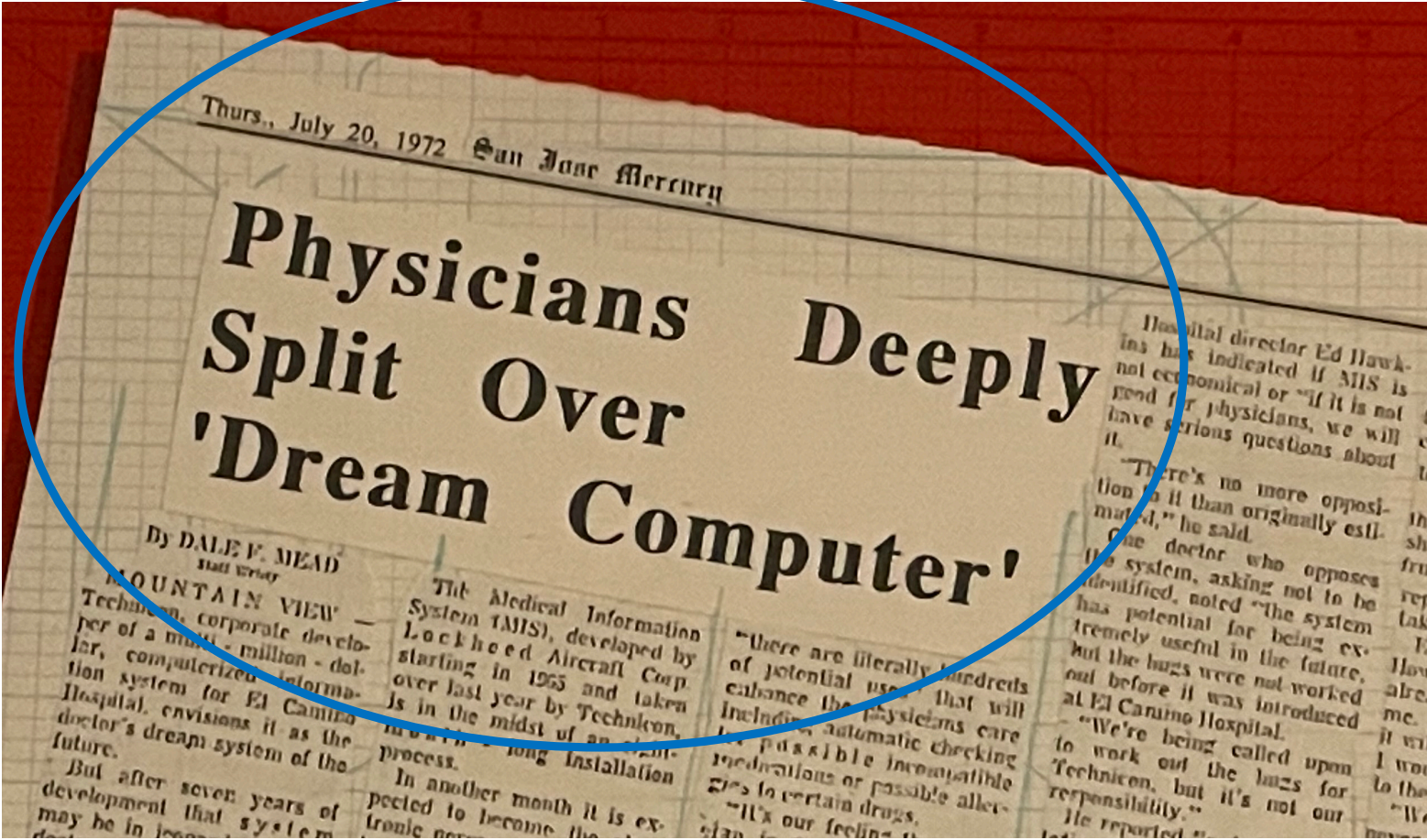

## 'Work-Saving' Computer – June 1973

Friday, June 1, 1973 ★★ San Jose News

# 'Work-Saving' Computer Enslaves Hospital Staff, Doctors Claim

By DALE MEAD  
*Staff Writer*

**MOUNTAIN VIEW —** El Camino Hospital's experimental computerized patient records bank isn't the system that should serve the hospital in the future, the board of directors has been told.

The Lockheed-developed Medical Information System (MIS), intended to keep track of all the paperwork on a patient from admission to

per cent of the staff doctors in a poll favored a halt to the Federally funded project.

Thursday evening, almost 50 doctors appeared for a special meeting with the five-member board on the matter, and many of them complained of wasted time, potentially dangerous errors and tension arising from the project.

The opponents, members of a committee formed to

provided a "Niagra Falls" of often baffling reports, required them to use complex methods of issuing simple orders, and often made data — or even medications — unreachable on short notice.

Dr. Richard Cochran, a psychiatrist, claimed in one case he was not able to get an injection to calm a combative patient because "a nurse said the compute can't take the order that fast."

Ironically, devices occupied nurses so that they spent less time with patients.

"Our nurses are not as available now" on the wards, and "their intervening is crucial in our (psychiatric) department. A nurse can learn things you (the doctor) can't. She's on the ward more."

And MIS "has made a 12-step procedure out of issuing the orders I used to just

## U.S. Offers More Aid – August 1973

SAN JOSE NEWS, Wed., August 1, 1973

### U.S. Offers More Aid

# 'Automated Hospital' Backed

MOUNTAIN VIEW — A U.S. Department of Health, Education and Welfare (HEW) official says the controversial computerized information system at El Camino Hospital is highly feasible and his department's commitment of several hundred thousand dollars more for another year's evaluation of the system.

But the government believes it's worth the money, says Gerald Cohen, assistant director of the program. "The country is as well developed. MIS is a considerable achievement with all its faults."

Cohen said data gathered in an independent study by Battelle Columbus Labora-

Technicon (which built the MIS system) representatives have objected to portions of the Battelle report, arguing that the specific means of phrasing some questions and interpreting the responses created a cumulative bias against MIS.

#### SCORING

If doctors believed that certain effects of the system

## Drawing a World-Wide Audience – August 1973

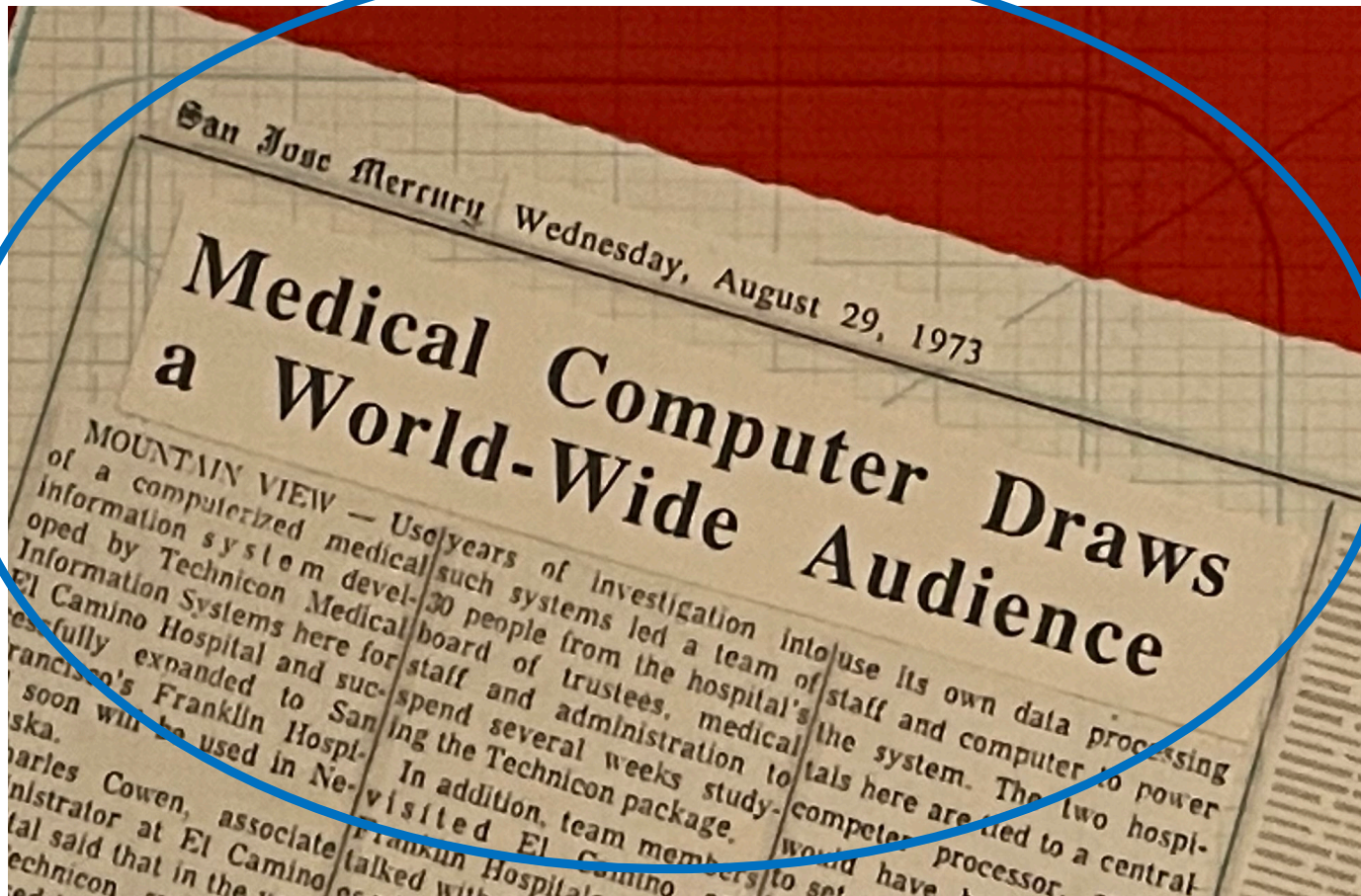

# Nurses Love the System

94% of nursing staff vote to retain the system  
in August 1974 secret ballot



# Nurses showoff MIS at 1974 Nursing Convention



July, 1974 • EL CAMINO HOSPITAL • EMPLOYEES' NEWSLETTER • MOUNTAIN VIEW, CALIF. • Vol. 13, No. 3

## ECH Nurses Star at ANA Convention



More than forty nurses from El Camino were able to spend some time at the ANA Convention held in San Francisco from June 9 through 12th. Nursing shared a convention booth with Technicon where our new nurse care planning system and MIS were demonstrated to 10,000 visiting nurses. Probably the most significant aspect of the Convention was the awed interest generated by our system. Some could not believe that there existed such a sophisticated system for extending the arm of nursing and medicine in hospitals.

Our nurses reported that 29 Standard Nursing Care Plans were sold at the convention and 1,200 brochures were handed out. Orders have been coming in at a steady pace since the June 1st publication date.

We are not sure how many MIS systems were sold, but two of our nurses claim they sold at least one each!

*Report from Nursing Service*



One of the busiest of the ANA Convention Exhibit areas: the El Camino and Technicon booth.

# El Camino Hospital Signs Long-Term Contract, Commercial Expansion begins

August 1974



IEEE Milestone Recognition

## Dr. Ralph Watson reports on benefits – July 1975

*University and Hospital Edition of Medical Tribune and Medical News*

# Hospital Tribune

Monday, July 14, 1975  
Vol 9, No. 14

*world news of medicine and its practice—fast, accurate, complete*

©1975, Medical Tribune, Inc.



Dr. Ralph J. Watson, a Los Altos surgeon who is chairman of El Camino's medical MIS committee, writes an order for "rainbow insulin coverage" on a Video Matrix Terminal (VMT).

### ***Surgeons Enthusiastic, But Internists Skeptical***

## **Hospital Info System Lowers Costs, Upgrades Care**

*Hospital Tribune Report*

MOUNTAIN VIEW, CALIF. — Paperwork—a major problem for hospitals because of the time and money involved—has been virtually eliminated by a pioneering installation at 450-bed El Camino hospital here.

Edwin Hawkins told *Hospital Tribune* that MIS has also speeded up many patient services, slightly shortening the average patient stay, and has improved the quality of patient care by eliminating many potential errors.

Melville Hodge, president of Technicon Medical Information Systems Corp., a subsidiary of Technicon Corp., which purchased MIS from Lockheed in 1971, explained in an interview that the system was designed with the twin goals of reducing hospital costs and improving the

# National Institute of Health Signs Up — June 1975

*To D.H. Bishop  
Route to you see ft  
Bob  
Pog*

*Also note pages 6-10*

**CLINICAL CENTER**

# LOSEUP

U.S. DEPARTMENT OF HEALTH, EDUCATION, AND WELFARE  
National Institutes of Health

Published by and for Employees

**NIH**

August 1975

## Hospital-wide Computer System Planned for CC

The NIH recently signed a contract with Technicon Medical Information Systems, Inc., to provide a computerized hospital information system for the Clinical Center.

The system will gather, transmit, and store for later use, medical information about Clinical Center patients.

It will collect background information on a patient prior to admission to the Clinical Center and record all events and medical orders which take place during the patient's stay.

The system may also be used to store clinical research protocols to assist investigators in carrying out clinical studies.

Display terminals will be installed at each nursing unit and patient service area (Diagnostic Radiology, Pharmacy, etc.). Each terminal is a 12-inch black and white television set with a keyboard typewriter and "light pen." A fast, quiet printer will also be installed with the terminal for printing physicians' orders, nursing plans, laboratory reports, and



On hand for the contract signing were the president of Technicon Medical Information Systems, Inc., Melville Hodge (right), Richard Langston, NIH contracting officer (left), Joseph Gray, contract negotiator (standing, second left), Dr. Thomas Lewis, chief, CC Office of Clinical and Management Systems (standing, second, right), Dr. David Swedlow, OCAMS (standing left), and Gerald Macks, management analyst, OCAMS (standing right).

## Battelle Institute Makes Report to HEW— December 1975



## Wall St Journal Reports Praise for MIS – January 1976

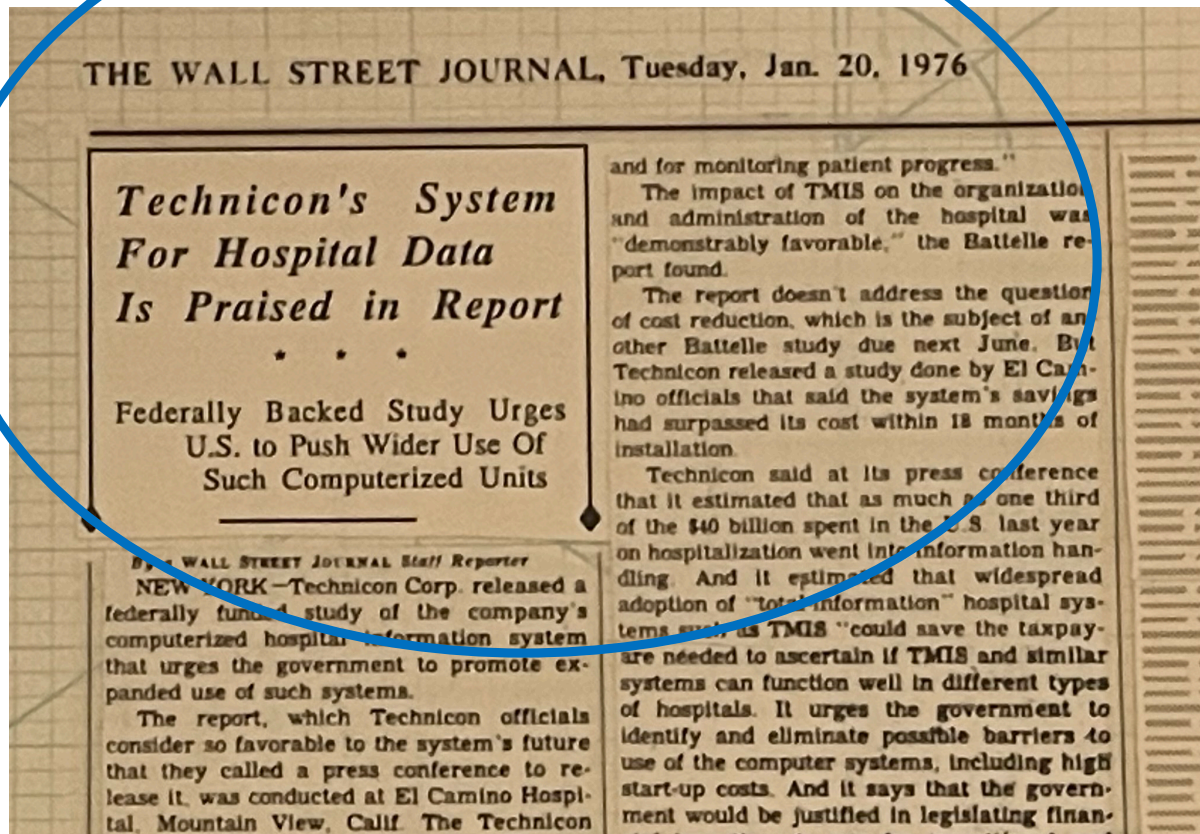

## Initial MIS Hospital Installations

### First MIS-I Installations

- 1972 **El Camino Hospital goes live**
- 1973 **Franklin Hospital** – San Francisco, CA
- 1974 **Nebraska Methodist** – Omaha, NE
- 1975 **St. Barnabas Medical Ctr** – Livingston, NJ  
**Maine Medical Center** – Portland, ME
- 1976 **National Institute of Health** – Bethesda, MD  
**Indiana Methodist Hospital** – Indianapolis, IN  
**U of Colorado Medical Ctr** – Denver, CO  
**Temple University** – Philadelphia, PA

# Revlon Buys TMIS from Technicon Corp

1980

Money is used to fund the Whitehead Institute for Medical Research at MIT

## Whitehead Institute at MIT Founded with Technicon Proceeds - 1982



1982

### Whitehead Institute Founded

(Jack Whitehead seated at left)

“The Whitehead Institute was founded by visionary industrialist and philanthropist Edwin C. “Jack” Whitehead, who was driven by a singular vision: to assemble a cadre of the world’s finest biomedical researchers under one roof and eliminate virtually any impediment to their pursuit of scientific discovery.”

# Whiteheads Buy Back Business from Revlon, Becomes Technicon Data Systems (TDS)

1986

Led by Jack Whitehead (Chmn), John Whitehead (CEO), Mel Hodge (Director)

**Installed in 83 hospitals**



IEEE Milestone Recognition



## Business Sold to AllTel in 1993 — Other Owners Follow

Was still running legacy system on Mainframe with >20M lines of assembler code

**Installed by more than 200 institutions**



IEEE Milestone Recognition

# MIS lifespan at El Camino Hospital

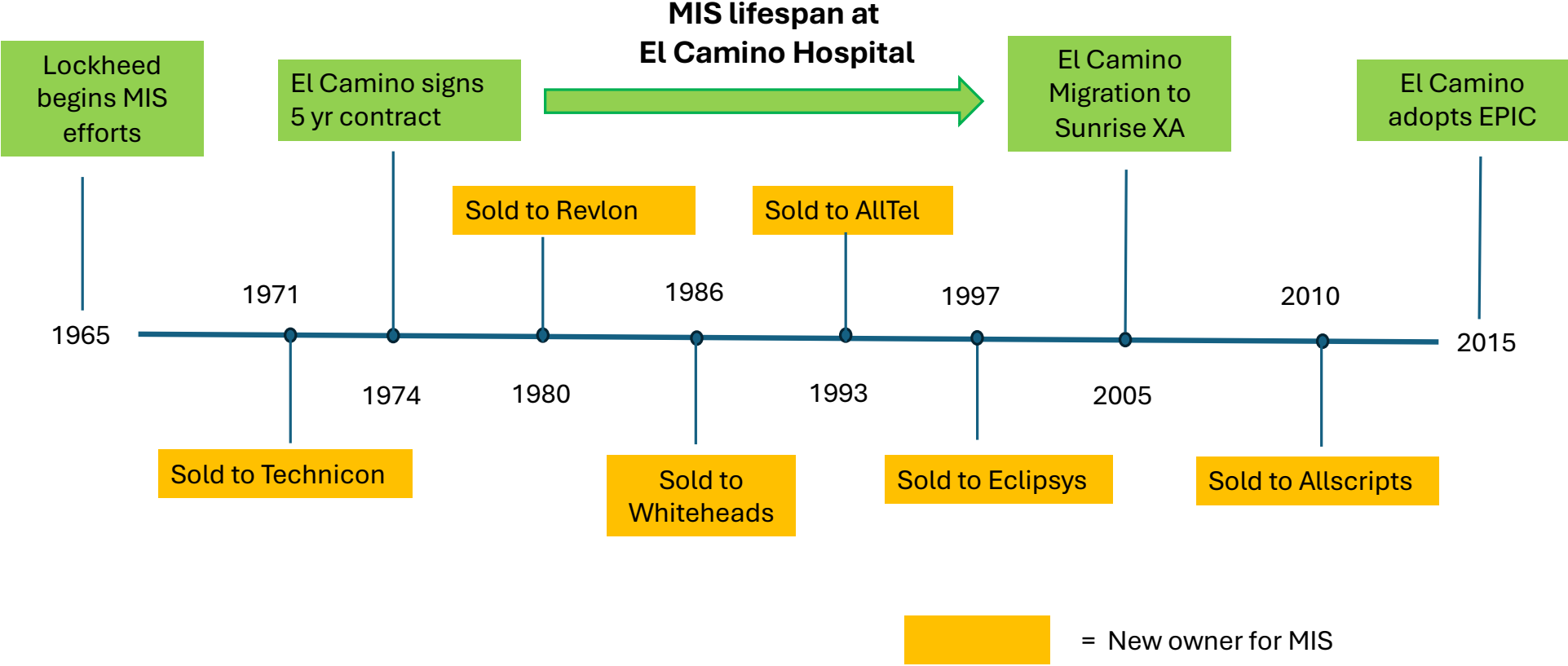

# Thank You for Your Support!

## With Gratitude to:

- El Camino Health Executive Team, Foundation, and Library
- IEEE Silicon Valley Chapter and History Committee
- Computer History Museum Archives
- Lockheed Martin and Retirees
- Planning Team, Hospitality and Production Crew
- Doctors, Nurses, and Caregivers that serve us every day

Stay tuned for video and historical information on website